

TYPE	INTRINSIC STANDOFF RATIO $\eta$		INTERBASE RESISTANCE $r_{BB}$		PEAK-POINT CURRENT $I_p$	EMITTER REV. CURRENT $I_{EB20 @ V_{B2E}}$		VALLEY-POINT CURRENT $I_v$	BASE 1 PEAK VOLTAGE $V_{OB1}$	CASE
	MIN.	MAX.	MIN.	MAX.	MAX.	MAX.		MIN.	MIN.	
			k $\Omega$	k $\Omega$	$\mu A$	$\mu A$	V	mA	V	
2N2417	0.51	0.62	4.7	6.8	12	2.0	60	8.0	-	
2N2417A	0.51	0.62	4.7	6.8	12	2.0	60	8.0	3.0	
2N2417B	0.51	0.62	4.7	6.8	6.0	0.2	30	8.0	3.0	
2N2418	0.51	0.62	6.2	9.1	12	2.0	60	8.0	-	
2N2418A	0.51	0.62	6.2	9.1	12	2.0	60	8.0	3.0	
2N2418B	0.51	0.62	6.2	9.1	6.0	0.2	30	8.0	3.0	
2N2419	0.56	0.68	4.7	6.8	12	2.0	60	8.0	-	
2N2419A	0.56	0.68	4.7	6.8	12	2.0	60	8.0	3.0	
2N2419B	0.56	0.68	4.7	6.8	6.0	0.2	30	8.0	3.0	
2N2420	0.56	0.68	6.2	9.1	12	2.0	60	8.0	-	
2N2420A	0.56	0.68	6.2	9.1	12	2.0	60	8.0	3.0	
2N2420B	0.56	0.68	6.2	9.1	6.0	0.2	30	8.0	3.0	
2N2421	0.62	0.75	4.7	6.8	12	2.0	60	8.0	-	
2N2421A	0.62	0.75	4.7	6.8	12	2.0	60	8.0	3.0	
2N2421B	0.62	0.75	4.7	6.8	6.0	0.2	30	8.0	3.0	
2N2422	0.62	0.75	6.2	9.1	12	2.0	60	8.0	-	
2N2422A	0.62	0.75	6.2	9.1	12	2.0	60	8.0	3.0	
2N2422B	0.62	0.75	6.2	9.1	6.0	0.2	30	8.0	3.0	
2N2646	0.56	0.75	4.7	9.1	5.0	12	30	4.0	3.0	
2N2647	0.68	0.82	4.7	9.1	2.0	0.2	30	8.0	6.0	
2N2840	0.62*	-	4.7	9.1	10	1.0	30	.20	-	
2N3980	0.68	0.82	4.0	8.0	2.0	0.01	30	1.0	6.0	
2N4851	0.56	0.75	4.7	9.1	2.0	0.1	30	2.0	3.0	
2N4852	0.70	0.85	4.7	9.1	2.0	0.1	30	4.0	5.0	
2N4853	0.70	0.85	4.7	9.1	0.4	0.05	30	6.0	6.0	
2N4947	0.51	0.69	4.0	9.1	2.0	0.01	30	4.0	3.0	
2N4948	0.55	0.82	4.0	12	2.0	0.01	30	2.0	6.0	
2N4949	0.74	0.86	4.0	12	1.0	0.01	30	2.0	3.0	
2N5431	0.72	0.80	6.0	8.5	0.4	0.01	30	2.0	1.0	
MU20	0.50	0.85	4.0	10	5.0	1.0	30	1.0	3.0	
MU2646M	0.56	0.75	4.7	9.1	5.0	12	30	2.0	3.0	

\*Typical Value

TABLE C UNIJUNCTION TRANSISTORS TO-92 CASE



TYPE	INTRINSIC STANDOFF RATIO $\eta$		INTERBASE RESISTANCE $r_{BB}$		PEAK-POINT CURRENT $I_p$	EMITTER REV. CURRENT $I_{EB20 @ V_{B2E}}$		VALLEY-POINT CURRENT $I_v$	BASE 1 PEAK VOLTAGE $V_{OB1}$	CASE
	MIN.	MAX.	MIN.	MAX.	MAX.	MAX.		MIN.	MIN.	
			k $\Omega$	k $\Omega$	$\mu A$	$\mu A$	V	mA	V	
2N4870	0.56	0.75	4.0	9.1	5.0	1.0	30	2.0	3.0	
2N4871	0.70	0.85	4.0	9.1	5.0	1.0	30	4.0	5.0	
MU10	0.50	0.85	4.0	10	5.0	1.0	30	1.0	3.0	
MU2646	0.56	0.75	4.7	9.1	5.0	12	30	4.0	3.0	
MU4891	0.55	0.82	4.0	9.1	5.0	0.01	30	2.0	3.0	
MU4892	0.51	0.69	4.0	9.1	2.0	0.01	30	2.0	3.0	
MU4893	0.55	0.82	4.0	12	2.0	0.01	30	2.0	6.0	
MU4894	0.74	0.86	4.0	12	1.0	0.01	30	2.0	3.0	

TABLE D PROGRAMMABLE UNIJUNCTION TRANSISTORS TO-92 CASE

TYPE	MAXIMUM RATINGS		GATE TO ANODE LEAKAGE CURRENT $I_{GAO @ 40v}$	PEAK CURRENT $I_p$		VALLEY CURRENT $I_v$		CASE
	GATE TO ANODE REVERSE VOLTAGE $V_{GAR}$	DC ANODE CURRENT $I_T$		$R_G = 10k\Omega$		$R_G = 1.0M\Omega$		
			MAX.	MAX.	MAX.	MIN.	MAX.	
	V	mA	nA	$\mu A$	$\mu A$	$\mu A$	$\mu A$	
2N8027	40	150	10	5.0	2.0	70	50	
2N8028	40	150	10	1.0	0.15	25	25	
A7T8027	40	150	10	5.0	2.0	70	50	
A7T8028	40	150	10	1.0	0.15	25	25	

# CASE OUTLINE DRAWINGS

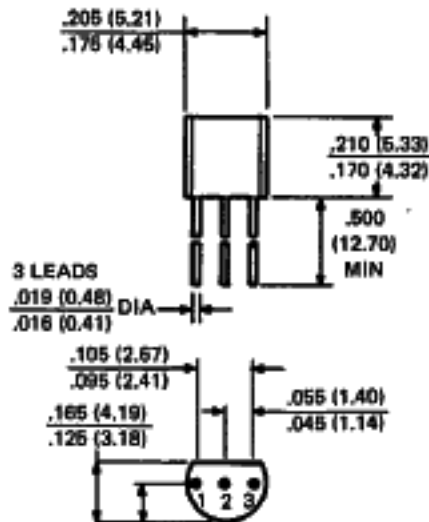

**LEAD CODE:**  
1. BASE 1  
2. EMITTER  
3. BASE 2

**TO-92 (UJT)**

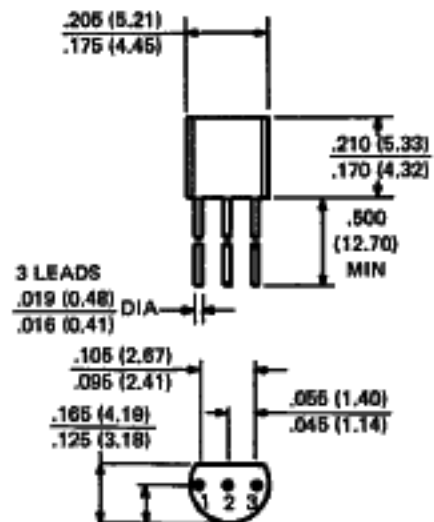

**LEAD CODE:**  
1. ANODE (A)  
2. GATE (G)  
3. CATHODE (K)

**TO-92 (PUT)**

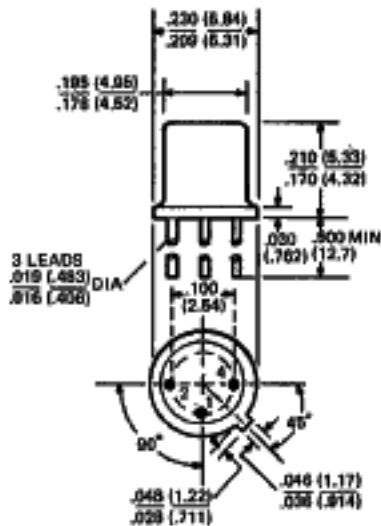

**LEAD CODE:**  
1. EMITTER  
2. BASE 1  
4. BASE 2

**TO-18\***

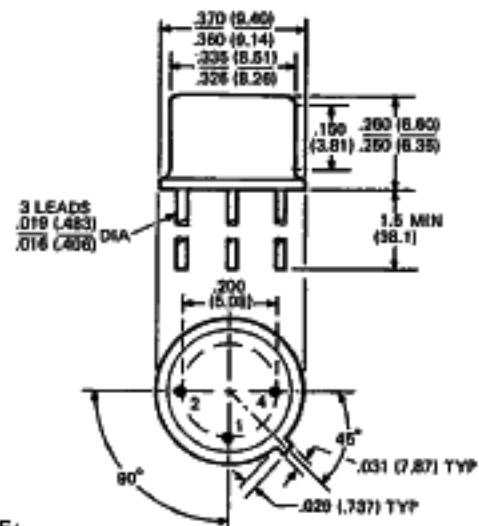

**LEAD CODE:**  
1. EMITTER  
2. BASE 1  
4. BASE 2

**TO-5\***

DIMENSIONS IN INCHES (MILLIMETERS)

DRAWINGS NOT TO SCALE.

\*Conforms to JEDEC outline except for lead configuration.

TM

# Central Semiconductor Corp.

145 Adams Avenue  
Hauppauge, NY 11788  
Tel: (516) 435-1110  
TWX: (510) 224-6493

MANUFACTURERS OF DISCRETE SEMICONDUCTORS

# CASE OUTLINE DRAWINGS

D

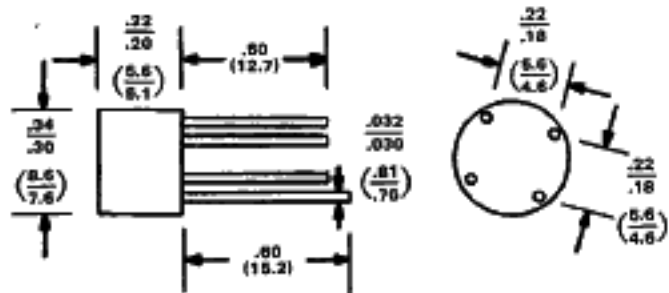

**CASE A** CBR1 Series  
CBR2 Series

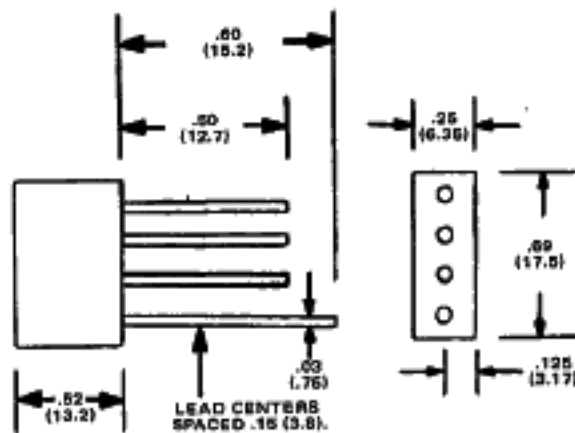

**CASE B** CBR1-L Series  
CBR2-L Series

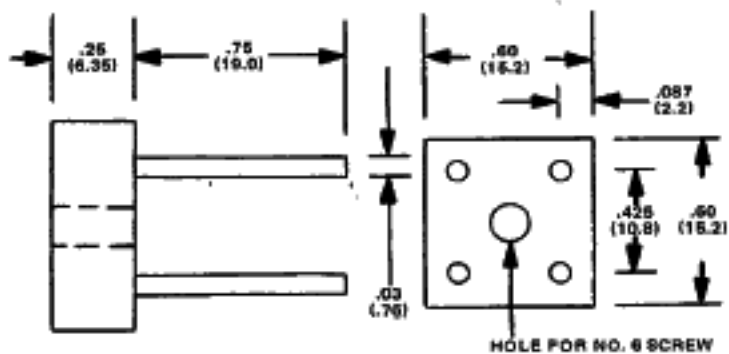

**CASE C** CBR3-P Series

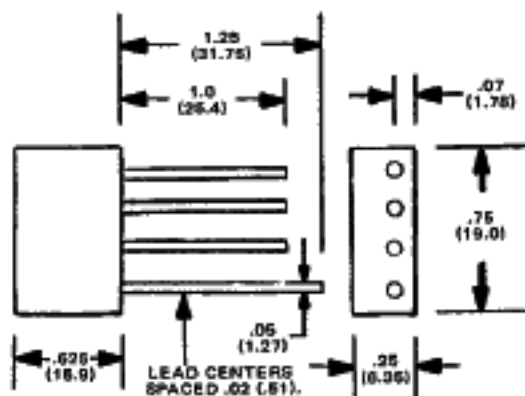

**CASE D** CBR4-L Series

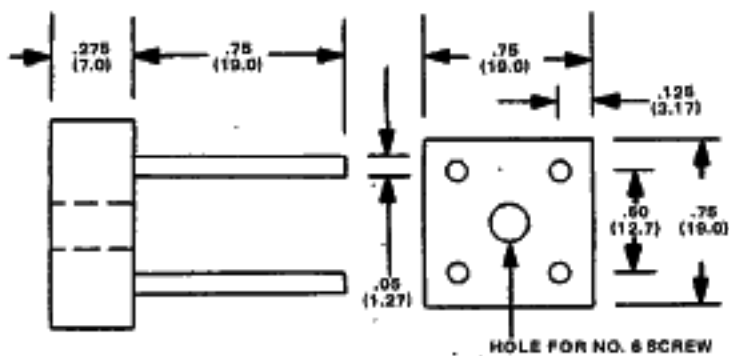

**CASE E** CBR8 Series

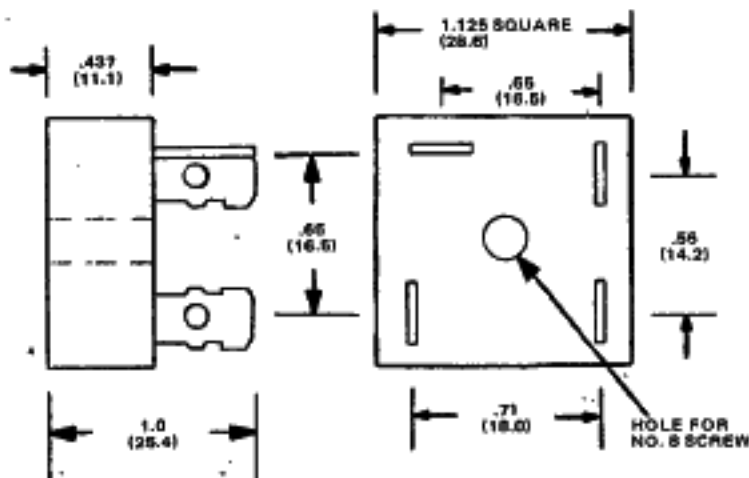

**CASE F** CBR10 Series, CBR25 Series  
CBR12 Series, CBR30 Series

All Dimensions in Inches (Millimeters)  
Drawings Not To Scale

f

# MECHANICAL OUTLINE DRAWINGS

2

### TO-5

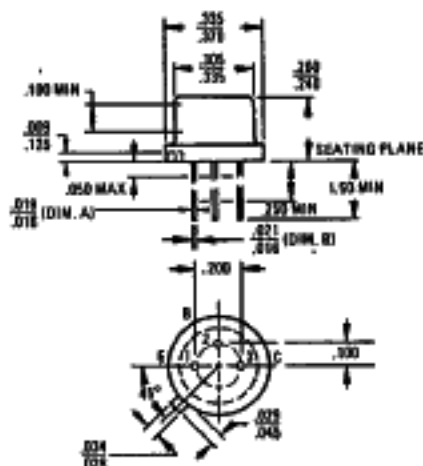

### TO-18

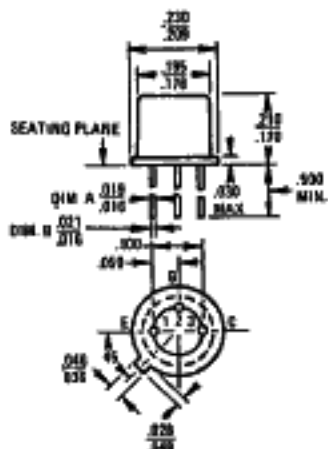

### TO-39

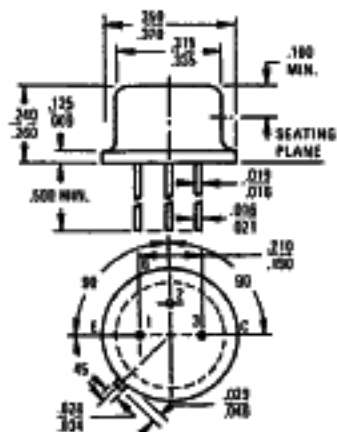

### TO-46

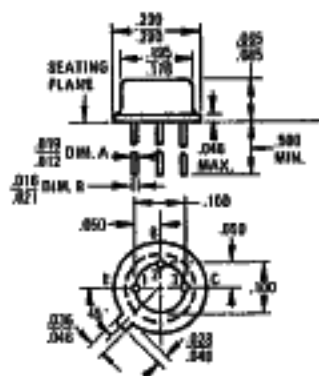

### TO-72

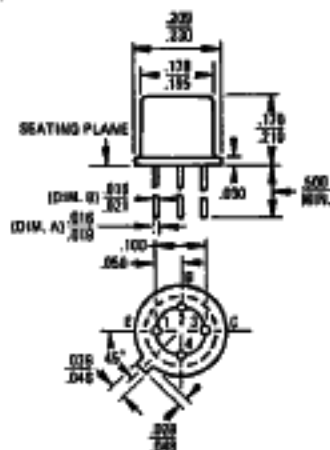

### TO-92

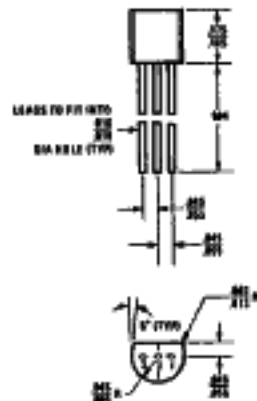

### TO-98

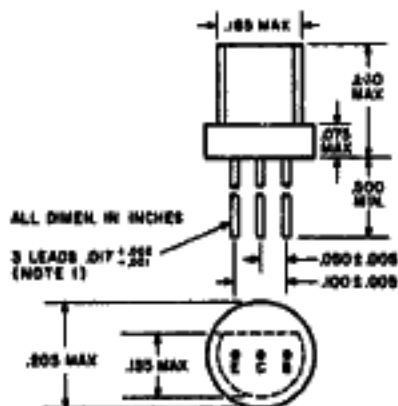

### TO-105

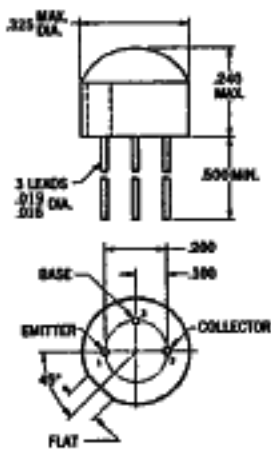

### TO-106

